

60-42
90-42
120-42
150-42

FEATURES	60-42		90-42		120-42		150-42	
Version	BM	XT	BM	XT	XT	TR	XT	TR
Motor Power - hp (kW)	30 (22)	40 (30)	40 (30)	50 (37)	60 (45)	40 (30)	60 (45)	50 (37)
Feed Opening - in. (mm)	24.5x16.5 (620 x 420)		35.8x16.5 (910 x 420)		47.2x16.5 (1200 x 420)		59x16.5 (1500 x 420)	
Knives / Counterknives	3/2	3-5/2	3/2	3-5/2	5/2		5/2	
Rotor Diameter - in. (mm)	14.2 (360)		14.2 (360)		14.2 (360)		14.2 (360)	
Standard Screen - in. (mm)	11/32" (9)		11/32" (9)		11/32" (9)		11/32" (9)	
Output Range - lbs/h (kg/h)	880-1320 (400-600)		1320-1980 (600-900)		1760-2640 (800-1200)		2640-3520 (1200-1600)	
Rotor Speed - rpm	580		580		580		580	
Weight - lbs (kg) SL	4202 (1910)		5170 (2350)		6160 (2800)		7480 (3400)	
Knives and Screen in Antiwear Steel	o		o		o		o	
Sound Proof Rigid Flap	o		o		x		x	
Traction Groups	x		x		o		o	
Hopper for Pipes and Sheets	o		o		o		o	
Sound Proof Version	o		o		o		o	
Hopper for Edge Trims	x	o	x	o	o	x	o	x
Sound Proof Tunnel for Conveyor Belt	o		o		o		o	
Level Control	o		o		o		o	
Rotor Lock Device for Maintenance	o		o		o		o	
Sensor for Belts Slippage	o		o		o		o	
Discharge for Vacuum Loader	o		o		x		x	
Discharge with Auger Screw	o		x		x		x	
Discharge with Suction Group on Board	o		o		x		x	
Discharge with Suction Group on Floor	o		o		o		o	

o = optional x = not available

TYPE	A	B	C
60-42 XT/BM in.	24.4	32.3	47.6
mm	620	820	1210
90-42 XT/BM in.	35.4	43.3	59
mm	900	1100	1500
120-42 XT/BM in.	47.2	55.1	76.8
mm	1200	1400	1950
150-42 XT/BM in.	59	66.9	90.6
mm	1500	1700	2300

TYPE	A	B
120-42 TR in.	88.6	47.6
mm	2250	1210
150-42 TR in.	98.4	59.4
mm	2500	1510

DIVISION

info@45consulting.com

PLASTICS

© TRIA America, LLC - ED 06.2012

DIVISION

PLASTICS

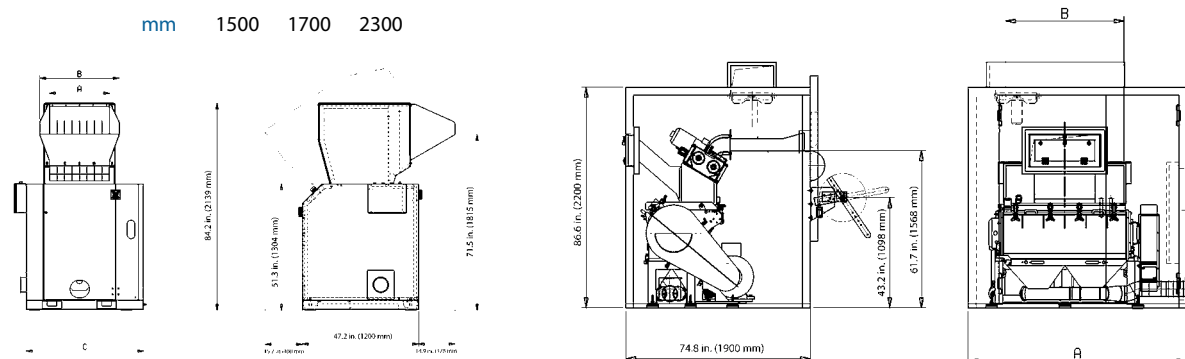

ACCESSORIES Conveyor Belt (Metal Detector, Soundproof Tunnel) - Depowdering System: DP & LT - Suction Group Available

Visit our Showroom in Charlotte, North Carolina.



TRIA America, LLC
10918 Granite Street
Charlotte, NC 28273
www.triaamerica.com

Tel: 704.944.3240
Tel: 877.505.8742
Fax: 704.716.0075
info@triaamerica.com



SCAN
HERE TO
LEARN
MORE



SERIES 42 XT-3M-TR

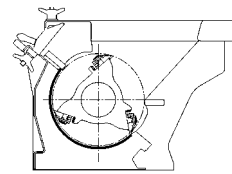

VERSION XT granulators designed for the granulation of extruded material, whether flexible or rigid. Also used as a secondary size reduction for pre-shredded material.

VERSION TR granulators are equipped with traction roll systems for the in-line and off-line grinding of film, sheets and thermoformed production waste.

VERSION BM granulators are designed specifically for the blow molding industry for the granulation of runners, blow molding rejects, in-line preforms at high temperatures and similar items.



DIVISION

PLASTICS

TRIA



Main maintenance parts accessible without tools
Screen cradle motion support by gas cylinder

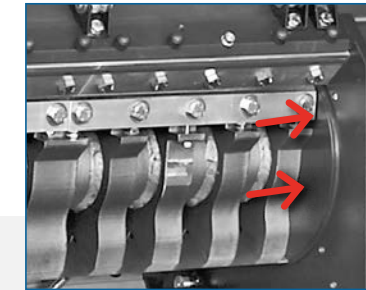

Rotor equipped with lateral discs

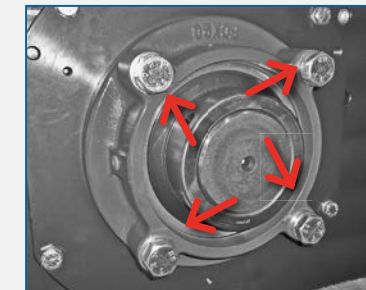

Roller bearings mounted to the grinding chamber



Flywheel and pulley mounted with taper-lock bushing

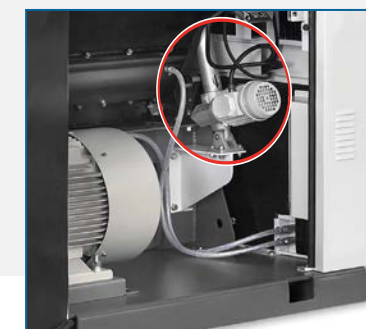

Motorized jack for hopper opening



3- to 5-knife rotor with arrow-cutting configuration



Rotor with scissors-cutting configuration



Adjustment of knives and counterknives can be performed separate from the machine

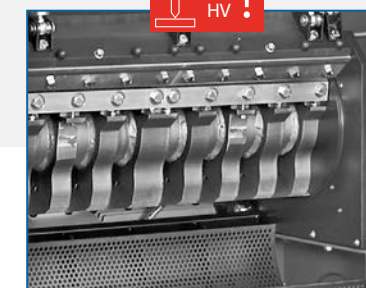

Grinding chamber in antiwear configuration



Screen equal to approx. 50% of the knives' rotation

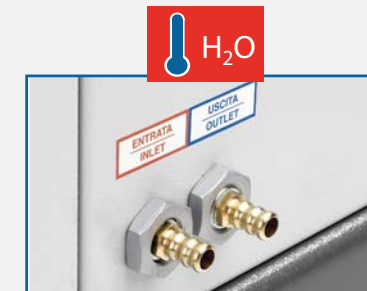

Water cooled cutting chamber



Pallet-style base (60 and 90) with included vibration dampers



Integrated electrical control panel

... All machines are manufactured according to the latest Safety Standards.